

SEMESTRAL ASSESSMENT 1

Primary 4 MATHEMATICS

4 MAY 2017

BOOKLET A

20 questions

40 marks

Total Time For Booklets A and B: 1 h 45 min

NAME : _____ ()

CLASS : PRIMARY 4 _____

DO NOT OPEN THIS BOOKLET UNTIL YOU ARE TOLD TO DO SO.

FOLLOW ALL INSTRUCTIONS CAREFULLY.

ANSWER ALL QUESTIONS.

Section A (20 x 2 = 40 marks)

For each question, four options are given. One of them is the correct answer. Make your choice (1, 2, 3 or 4). Shade the correct oval (1, 2, 3 or 4) on the Optical Answer Sheet.

1. In 81'209, what does the digit '2' stand for?

- (1) 20
- (2) 200
- (3) 2000
- (4) 20 000

2. How many hundreds are there in 23 600?

- (1) 6
- (2) 36
- (3) 236
- (4) 2360

3. What is 90 499 rounded to the nearest ten?

- (1) 90 000
- (2) 90 490
- (3) 90 500
- (4) 91 000

4. 1423, 1723, 2123, _____, 3223

Which one of the following is the missing number?

- (1) 2523
- (2) 2623
- (3) 2723
- (4) 2823

5. Which one of the following is not a factor of 30?

- (1) 5
- (2) 2
- (3) 3
- (4) 4

6. 2, 3 and 9 are some of the common factors of 18 and _____.

- (1) 12
- (2) 24
- (3) 27
- (4) 36

7. The sum of the first four multiples of 6 is _____.

- (1) 60
- (2) 24
- (3) 12
- (4) 10

8. The figure below is made up of 4 identical squares

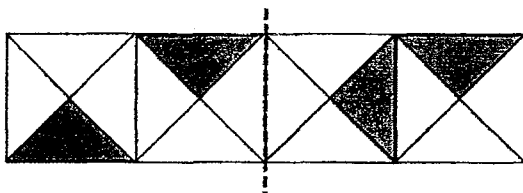

Using the dotted line as the line of symmetry, how many triangles must you shade so that the figure is symmetrical?

- (1) 1
- (2) 2
- (3) 3
- (4) 4

9. During a match, 6312 students were put into groups of 7.
How many students were in groups of 7?

- (1) 901
- (2) 910
- (3) 6300
- (4) 6307

Use the diagram below to answer Questions 10 and 11.

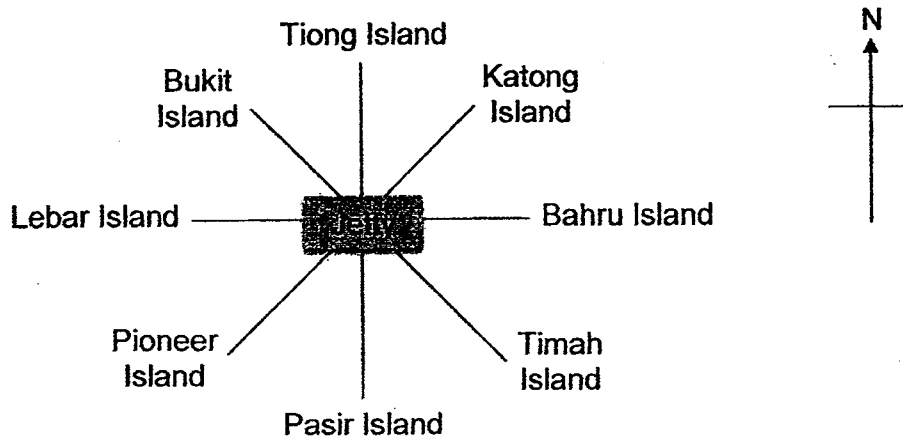

10. Bukit Island is _____ of the jetty.

- (1) north-east
- (2) north-west
- (3) south-east
- (4) south-west

11. Ahmad is at the jetty, facing Lebar Island. He makes a $\frac{3}{4}$ -turn in an anti-clockwise direction. Which island will he be facing?

- (1) Pasir Island
- (2) Timah Island
- (3) Katong Island
- (4) Tiong Island

12. Joshua's swimming lesson started at 9.15 a.m. and ended at 10.30 a.m. How many right angles did the minute hand move during this duration?

- (1) 7
- (2) 6
- (3) 5
- (4) 4

13. A rectangular piece of paper is folded as shown below. Find $\angle x$.

- (1) 24°
- (2) 33°
- (3) 42°
- (4) 66°

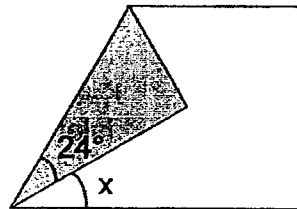

14. Nora's monthly salary is \$2470. She spends \$1560 and saves the rest every month. How much will she save in 4 months?

- (1) \$910
- (2) \$3640
- (3) \$4440
- (4) \$6240

15. How many of the letters below have a line of symmetry?



- (1) 1
- (2) 2
- (3) 3
- (4) 4

16. David was at a certain position. He moved 3 steps west and 2 steps south. Finally, he took one step east. He ended up at position X. What was his starting position?

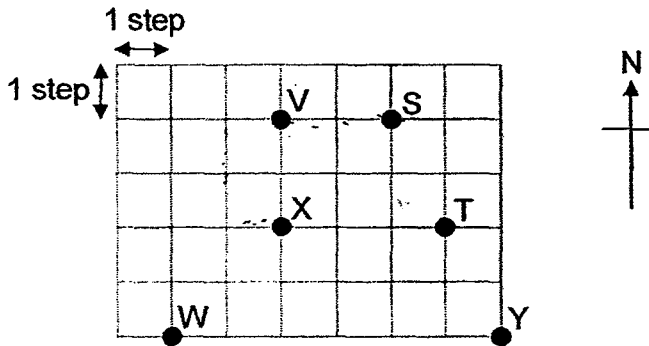

- (1) S
- (2) T
- (3) W
- (4) Y

17. Study the pattern below carefully.

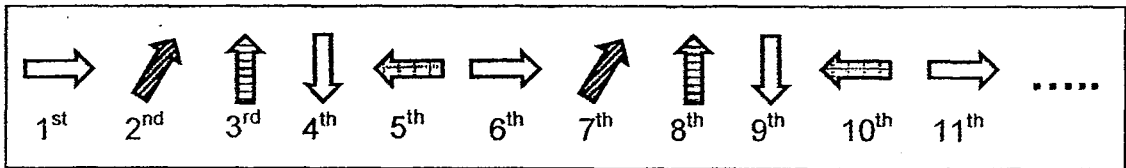

The pattern continues in the same manner. What will the 22nd arrow be?

- (1)
- (2)
- (3)
- (4)

18. A piece of cloth covered half of the symmetrical figure as shown below. Which one of the following would be the complete figure when the cloth is removed?

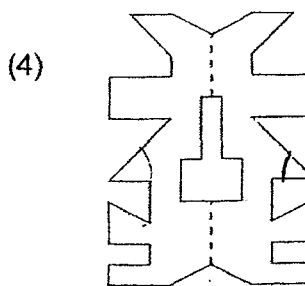
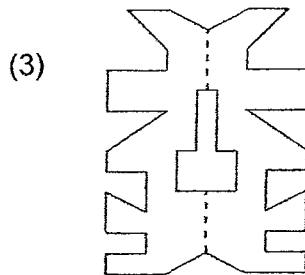
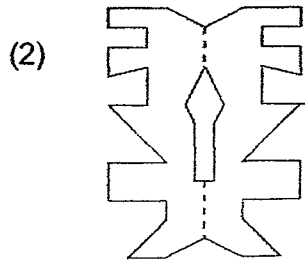
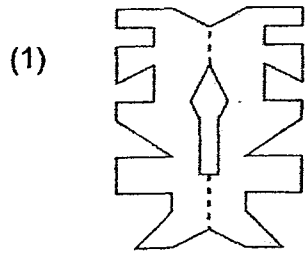
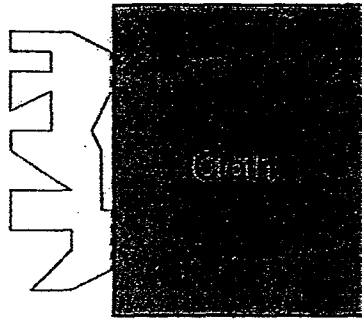

19. The figure below is made up of two rectangles and a square. Find the length of one side of the square.

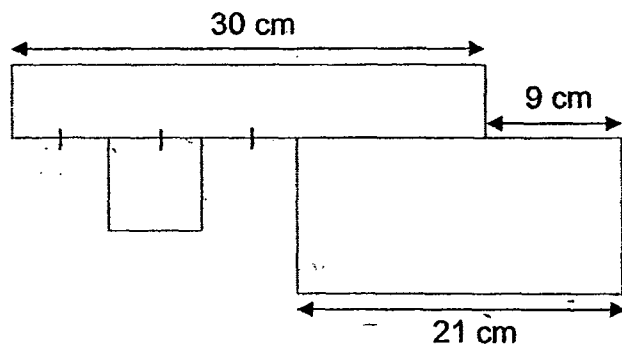

- (1) 6 cm
(2) 7 cm
(3) 3 cm
(4) 4 cm
20. Alice, Bernard, Carrie, Daniel and Elijah went to a party. If every one of them shook hands with each other only once, how many handshakes were there altogether?
- (1) 20
(2) 10
(3) 9
(4) 4



MARIS STELLA HIGH SCHOOL (PRIMARY)

SEMESTRAL ASSESSMENT 1

Primary 4 MATHEMATICS

4 MAY 2017

BOOKLET B

25 questions

60 marks

Total Time For Booklets A and B: 1 h 45 min

NAME : _____ ()

CLASS : PRIMARY 4 _____

DO NOT OPEN THIS BOOKLET UNTIL YOU ARE TOLD TO DO SO.

FOLLOW ALL INSTRUCTIONS CAREFULLY.

ANSWER ALL QUESTIONS.

MARKS OBTAINED :

BOOKLET A: _____ / 40

BOOKLET B: _____ / 60

TOTAL : _____ / 100

Section B (20 x 2 = 40 marks)

Show your working clearly in the spaces below each question and write your answers in the spaces provided. For questions which require units, give your answers in the units stated.

Do not write in this space.

21. Write ninety-eight thousand, eight hundred and seventy-seven in numerals.

Answer: _____

22. Form the smallest 4-digit odd number using the digits below.
Do not begin your answer with '0'.

0 9 6 5 4

Answer: _____

23. Divide 6104 by 8.

Answer: _____

24. The product of 374 and 15 is _____.

Answer: _____

25. Complete the figure below using the dotted line as the line of symmetry. Colour the correct squares completely with a pencil.

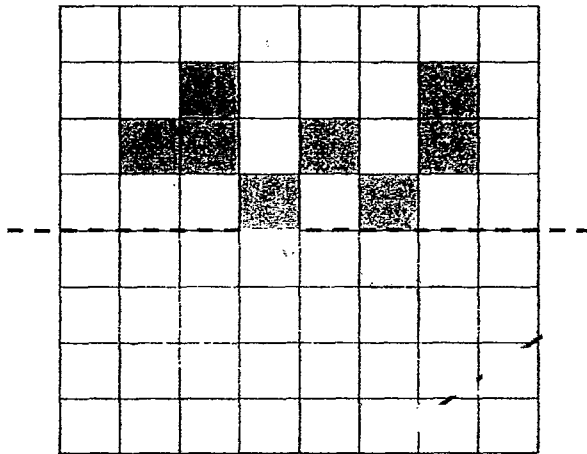

Do not write in this space.

26. Use the line below to draw $\angle ABC$ such that it is 145° . Mark out the angle and label point C in the figure.

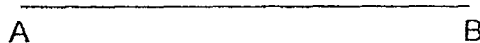

27. In $5\odot 03$, \odot stands for a digit. When $5\odot 03$ is divided by 9, the quotient is 567 with no remainder. What is \odot ?

Answer: _____

28. Jovan's saving was \$2500 when rounded to the nearest hundred. Find the **greatest** possible amount of money Jovan saved.

Do not write in this space.

Answer: \$ _____

29. Find the sum of the third multiple of 8 and sixth multiple of 5.

Answer: _____

30. A number is a factor of 32 but **not** a multiple of 4. It is more than 1. What is the number?

Answer: _____

31. Wei San had twice as many beads as Polly at first. Wei San gave 28 beads to Polly and they have the same number of beads now. How many beads did Wei San have at first?

Answer: _____

32. The figure below is not drawn to scale. QRST is a square. Find $\angle RQU$.

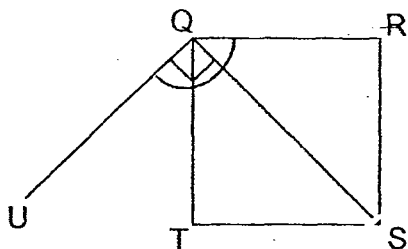

Answer: _____

33. Xiao Hao started with a number. He multiplied it by 4 and then added 8 to it. He had an answer of 136 in the end. What number did Xiao Hao start with?

Answer: _____

-
34. Farmer William built a pigsty 20 m long and 16 m wide. He placed each stake 4 m apart from the other to hold up the wire mesh. How many stakes did he use altogether to build the pigsty?

Answer: _____

35. Sylvia sold an equal number of muffins each day. She sold 420 muffins in 6 days. How many muffins would she sell in 30 days?

Answer: _____

36. Danny and Nicholas had \$800. After Danny spent \$130 and Nicholas spent \$220, Nicholas was left with 4 times as much as Danny. How much money had Danny in the end?

Answer: \$ _____

37. Jenny has some two-dollar notes and five-dollar notes. The total value of these notes is \$180. There are 6 more two-dollar notes than five-dollar notes. How many five-dollar notes does Jenny have?

Answer: _____

38. A shop is giving away 2 packets of wet wipes free for every 15 packets of orange juice purchased.

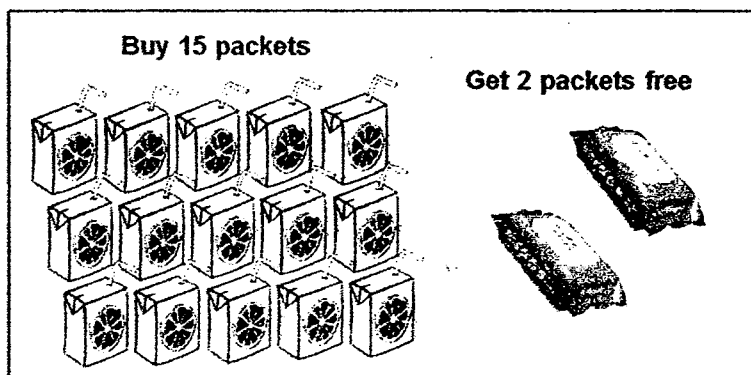

Mrs Fernandez bought orange juice from the shop and received 12 packets of wet wipes free. How many packets of orange juice did she buy?

Answer: _____

39. The figure below shows 4 identical rectangles. How many rectangles must you add to make the figure into a 12-cm square?

Answer: _____



40. Tables and chairs are arranged in a manner shown below.

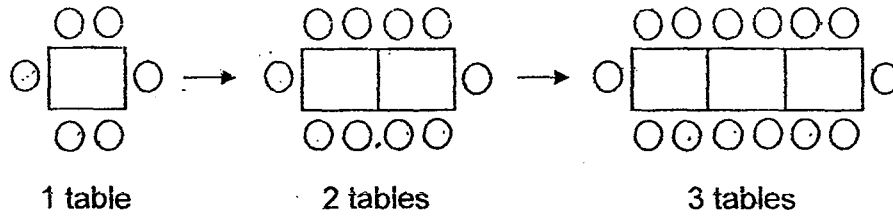

Do not
write in
this
space.

When **15 tables** are arranged in the same manner, how many chairs are needed?

Answer: _

Section C (5 x 4 = 20 marks)

Work out the answers for each of the following questions. All workings must be shown clearly in the space provided.

41. Mrs Wong bought 8 air tickets.
6 of them cost \$476 each and the rest cost \$1168 each.
How much did Mrs Wong spend on these air tickets altogether?

Answer: _____ [4]

42. There were 880 coins in Containers A and B.
After 52 coins were transferred from Container A to Container B, Container A has 3 times as many coins as Container B.

How many coins were in Container A at first?

Do not
write in
this
space.

Answer: _____ [4]

43. Matthias has to pack some biscuits into bags.
He has more than 40 but less than 75 biscuits.
If he puts 8 biscuits in each bag, he will be short of 7 biscuits.
If he puts 7 biscuits in each bag, he will have 2 biscuits left.

How many biscuits does Matthias have?

Do not
write in
this
space.

Answer: _____ [4]

44. The figure below is made up of 2 rectangles and 2 squares of different sizes. The perimeter of the figure is 70 cm. Find the length of EF.

Do not write in this space.

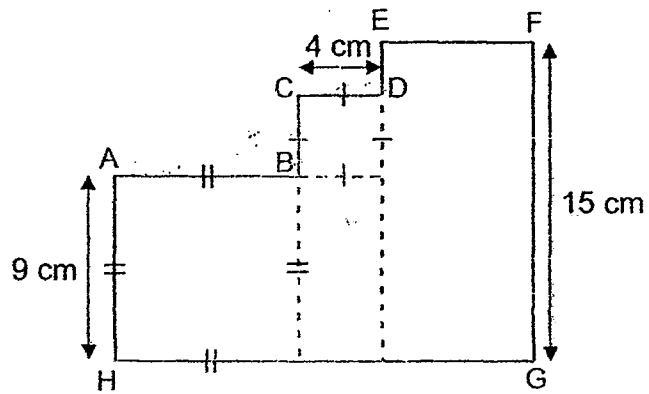

Answer: _____ [4]

45. Andika planned to give an equal number of stickers to the 19 friends he had invited to his birthday party.
However, one of them fell sick on that day and could not attend the party.
In the end, the rest of his friends received 2 more stickers each.

How many stickers did Andika give away at the party altogether?

Do not
write in
this
space.

Answer: _____ [4]

END.

EXAM PAPER 2017

LEVEL : PRIMARY 4
SCHOOL : Maris Stella High School (Primary)
SUBJECT : MATHEMATICS
TERM : SA1

Booklet A

Q1	Q2	Q3	Q4	Q5	Q6	Q7	Q8	Q9	Q10
2	3	3	2	4	4	1	4	4	2
Q11	Q12	Q13	Q14	Q15	Q16	Q17	Q18	Q19	Q20
4	3	3	2	2	1	3	1	1	2

Booklet B

Q21 98 877

Q22 4059

Q23 763

Q24 5610

Q25

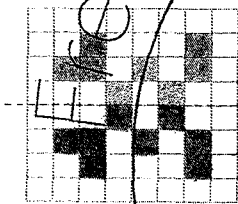

Q26

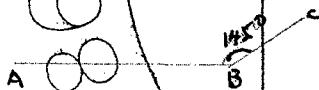

Q27 1

Q28 \$2549

Q29 54

Q30 2

Q31 112 beads

Q32 135°

Q33 32

Q34 18

Q35 2100 muffins

Q36 \$90

Q37 24 five-dollars notes

Q38 90 packets

Q39 8 rectangles

Q40 62 chairs

Booklet C

Q41 $\$476 \times 6 = \2856
 $\$1168 \times 2 = \2336
 $\$2856 + \$2336 = \$5192$

Q42 $880 \div 4 = 220$
 $220 \times 3 = 660$
 $660 + 52 = 712$

Q43

Multiple of 8	40	48	56	64	72
-7	33	41	49	57	65
Multiple of 7	42	49	56	63	70
+2	44	51	58	65	72

Q44 $(9+9+9+4+4+2+4+15)\text{cm} = 56\text{cm}$
 $(70 - 56)\text{cm} = 14\text{cm}$
 $14\text{cm} \div 2 = 7\text{cm}$

Q45 $19 - 1 = 18$
 $18 \times 2 = 36$
 $19 \times 36 = 684$

